

Linear

# SEN CV A030x2 (60W) Fixture Guide

# KKDÖ

Indoor/Outdoor | Surface | Output up to 4680lm/m (1426lm/ft)

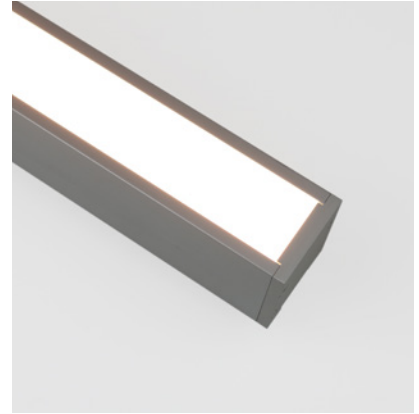

## Key applications

- ✓ Backlighting/Signage
- ✓ Building façades
- ✓ Ceiling
- ✓ Cove lighting
- ✓ Downlighting
- ✓ Flood lighting
- ✓ Interior/Exterior
- ✓ Public spaces
- ✓ Wall grazing
- ✓ Window Reveal

## Key features

- ✓ Custom lengths
- ✓ Diffusion: Spotting
- ✓ Direct view
- ✓ High lumen efficacy
- ✓ IP44
- ✓ IP67
- ✓ Lensed

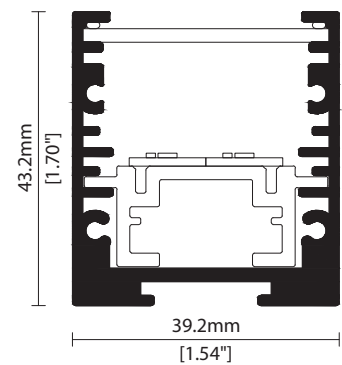

## MOUNTING METHODS



KKCP-12 Lock clip



KKBK-02 Fixed bracket



KKBK-09 Mounting plate



KKBK-16 Small adjustable bracket



KKBK-17 Large adjustable bracket



KKBK-23 Low adjustable bracket

Linear

# SEN CV A030x2 (60W)

## Specification sheet



<b>Dimensions</b>	H43.2/W39.2/L97-1520mm (H1.70/W1.54/L3.82-59.45in)
<b>PCB Cut-point</b>	38.46mm increment/1000mm max (1.51in increment/39.37in max)
<b>LED Pitch</b>	4.8mm - 208LED/m (0.19in - 64LED/ft)
<b>Chip</b>	<b>A-line</b>
<b>Cover/Optics</b>	80°(Clear cover) / 100° (Diffused Cover)
<b>CCT</b>	<b>A-line:</b> 2700K/3000K/4000K
<b>LED binning</b>	<b>A-line:</b> 3-step MacAdam ellipse
<b>CRI</b>	94
<b>Lifetime</b>	50,000 hours @ 25°C (50,000 hours @ 77°F)
<b>Operating temp</b>	T <sub>a</sub> = -25 to 45°C (T <sub>c</sub> max = 83.7°C) T <sub>a</sub> = -13 to 113°F (T <sub>c</sub> max = 183°F)
<b>IP Rating</b>	IP44/67
<b>Finish</b>	Silver anodised
<b>Mounting</b>	Surface mounting via brackets
<b>Power feed</b>	Sheathed hardwire tails or male/female connectors
<b>Control</b>	0-10V/1-10V/DMX/DALI



### LED Grading Key

**Exclusive Grade** \*KKDC tuned CCT range  
**A-line\*** 3-step CCT range  
 KKDC highest lumen efficacy LED

<b>Power consumption</b>	<b>Supply voltage</b>	<b>Supply current</b>
60W/m (18.29 W/ft)	24V DC	2.50A/m (0.76 A/ft)

### Performance Data (3000K)

<b>A-line</b>	R1	R2	R3	R4	R5	R6	R7	R8	R9	R10	R11	R12	R13	R14
	95	95	93	94	94	95	89	73	87	94	77	95	95	97

	<b>Clear Cover</b>	<b>Diffused Cover</b>	<b>Clear Cover + Micro Louvre</b>	<b>CRI</b>	<b>R9</b>	<b>Rf</b>	<b>Rg</b>
<b>A-line</b>	4680lm/m (1426lm/ft) 78lm/W	3660lm/m (1116lm/ft) 61lm/W	2400lm/m (732lm/ft) 40lm/W	94	73	-	-

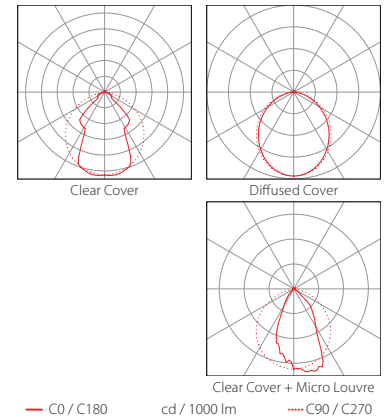
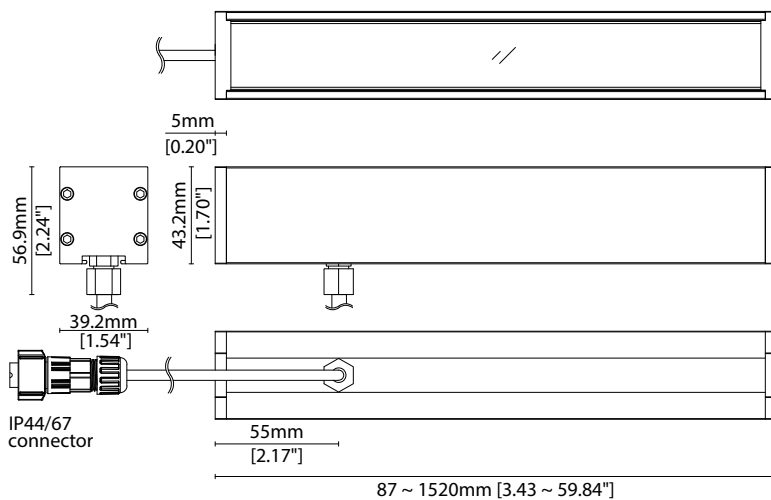

Data derived from independent UKAS/IESNA LM-79-08 accredited testing of production samples.

Linear

# SEN CV A030x2 (60W) Code Table



## FIXTURE

Model	Finish	Cover <sup>1</sup>	Grade <sup>2</sup>	LED	Colour	Length Availability <sup>3</sup>	IP	Cable Length	Power Feed <sup>4</sup>	Cable Exit <sup>5</sup>	Input	
SEN SN	Silver Anodised SA	Clear	B	A030 030	2700K <sup>6</sup> 27	m 87-1520mm 38.46mm increments	IP44 44	300mm /11.81"	Single ø6.3mm sheath tail	S00B	Rear Cable Exit RC	DC 24V g
		Diffused	C		3000K <sup>6</sup> 30	i 3.43-59.84in 1.51in increments	IP67 <sup>7</sup> 67		Double ø6.3mm sheath tail	D00B	Side Cable Exit <sup>8</sup> SC	
		Clear+ Micro Louvre	K		4000K 40		(Specify length code OR total run length)		Single ø6.3mm sheath IP67 connector	S67B		
								Double ø6.3mm sheath IP67 connector	D67B			

<sup>1</sup> Refer to **Cover Options** on **Options** pages

<sup>2</sup> Refer to **LED Grading Key** on **Specification sheet** page

<sup>3</sup> Refer to **Length Availability List** or enter total run length instead of length code

<sup>4</sup> Refer to **Power Feed Options** on **Options** pages

<sup>5</sup> Refer to **Cable Exit Options** on **Options** pages

<sup>6</sup> 2700K/3000K – 94CRI

<sup>7</sup> Due to the clear, flush potted polyurethane top layer on IP67 SEN CV A030 a colour shift of +/-20K should be expected

<sup>8</sup> Low adjustable bracket needs side cable exit option

## Code Example:

SN	-	SA	-	B	-	A	-	030	-	30	-	m	1251	-	64	-	300	-	S67B	-	RC	-	g
SEN		Silver anodised		Clear		A		A030		3000K			1251mm		IP64		300mm /11.81"		Single ø6.3mm sheath IP67 connector		Rear Cable Exit		DC 24V

## ACCESSORIES

### Mounting Accessories

KKCP-12	Lock Clip
KKBK-02	Fixed bracket
KKBK-09	Mounting plate
KKBK-16	Small adjustable bracket
KKBK-17	Large adjustable bracket
KKBK-23	Low adjustable bracket

\* Refer to **Mounting accessories** on **Accessories** pages

### Exterior Junction Boxes

KKJB-07	IP67 Slim J-Box
KKJB-07R	Potting Resin for IP67 Slim J-Box

\* Refer to **Exterior Junction Boxes** on **Accessories** pages

### PSU/Driver

1-10V/DALI/DMX

\* Refer to **Driver/PSU Options** page for details or provide requirement and KKDC to offer the suitable option

Linear

# SEN CV A030x2 (60W) Length Availability List



Length Code		Fixture Length <sup>1</sup>		LED Strip <sup>2</sup>		End Cap Dimension <sup>3</sup>		Wattage (W)	Output (lm)
Metric	Imperial(US)	Metric	Imperial(US)	Metric	Imperial(US)	Metric	Imperial(US)	3000K (Test Data)	3000K (Test Data)
m0097	i0003	97mm	3.43in	77mm	3.03in	10mm	0.39in	4.62	360
m0135	i0005	135mm	4.94in	115mm	4.55in	10mm	0.39in	6.93	541
m0174	i0006	174mm	6.45in	154mm	6.06in	10mm	0.39in	9.24	721
m0212	i0008	212mm	7.97in	192mm	7.57in	10mm	0.39in	11.54	900
m0251	i0009	251mm	9.48in	231mm	9.09in	10mm	0.39in	13.85	1080
m0289	i0011	289mm	11.00in	269mm	10.60in	10mm	0.39in	16.16	1260
m0328	i0013	328mm	12.51in	308mm	12.12in	10mm	0.39in	18.47	1441
m0366	i0014	366mm	14.02in	346mm	13.63in	10mm	0.39in	20.77	1620
m0405	i0016	405mm	15.54in	385mm	15.14in	10mm	0.39in	23.08	1800
m0443	i0017	443mm	17.05in	423mm	16.66in	10mm	0.39in	25.39	1980
m0482	i0019	482mm	18.57in	462mm	18.17in	10mm	0.39in	27.70	2161
m0520	i0020	520mm	20.08in	500mm	19.69in	10mm	0.39in	30.00	2340
m0559	i0022	559mm	21.60in	539mm	21.20in	10mm	0.39in	32.31	2520
m0597	i0023	597mm	23.11in	577mm	22.72in	10mm	0.39in	34.62	2700
m0635	i0025	635mm	24.62in	615mm	24.23in	10mm	0.39in	36.93	2881
m0674	i0026	674mm	26.14in	654mm	25.74in	10mm	0.39in	39.23	3060
m0712	i0028	712mm	27.65in	692mm	27.26in	10mm	0.39in	41.54	3240
m0751	i0029	751mm	29.17in	731mm	28.77in	10mm	0.39in	43.85	3420
m0789	i0031	789mm	30.68in	769mm	30.29in	10mm	0.39in	46.16	3600
m0828	i0032	828mm	32.19in	808mm	31.80in	10mm	0.39in	48.46	3780
m0866	i0034	866mm	33.71in	846mm	33.31in	10mm	0.39in	50.77	3960
m0905	i0035	905mm	35.22in	885mm	34.83in	10mm	0.39in	53.08	4140
m0943	i0037	943mm	36.74in	923mm	36.34in	10mm	0.39in	55.39	4320
m0982	i0038	982mm	38.25in	962mm	37.86in	10mm	0.39in	57.69	4500
m1020	i0040	1020mm	39.77in	1000mm	39.37in	10mm	0.39in	60.00	4680
m1059	i0041	1059mm	41.28in	1039mm	40.89in	10mm	0.39in	62.31	4860
m1097	i0043	1097mm	42.79in	1077mm	42.40in	10mm	0.39in	64.62	5040
m1135	i0044	1135mm	44.31in	1115mm	43.91in	10mm	0.39in	66.93	5221
m1174	i0046	1174mm	45.82in	1154mm	45.43in	10mm	0.39in	69.23	5400
m1212	i0047	1212mm	47.34in	1192mm	46.94in	10mm	0.39in	71.54	5580
m1251	i0049	1251mm	48.85in	1231mm	48.46in	10mm	0.39in	73.85	5760
m1289	i0050	1289mm	50.36in	1269mm	49.97in	10mm	0.39in	76.16	5940
m1328	i0052	1328mm	51.88in	1308mm	51.49in	10mm	0.39in	78.46	6120
m1366	i0053	1366mm	53.39in	1346mm	53.00in	10mm	0.39in	80.77	6300
m1405	i0055	1405mm	54.91in	1385mm	54.51in	10mm	0.39in	83.08	6480
m1443	i0056	1443mm	56.42in	1423mm	56.03in	10mm	0.39in	85.39	6660
m1482	i0058	1482mm	57.94in	1462mm	57.54in	10mm	0.39in	87.69	6840
m1520	i0059	1520mm	59.45in	1500mm	59.06in	10mm	0.39in	90.00	7020

<sup>1</sup> Actual total overall length of light fixture (LED strip + end caps + void/wire hole)

<sup>2</sup> Actual length of PCB strip

<sup>3</sup> Actual length of 2x end caps

Linear

# SEN CV A030x2 (60W)

## Length Availability List

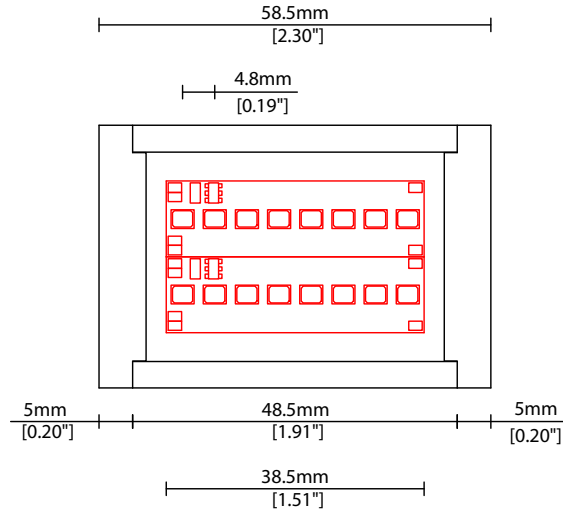

Linear

# SEN CV A030x2 (60W) Options

# KKDÖ

## COVER OPTIONS

\* Options are an integral part of the fixture ordering codes. Please refer to **Code Table** pages.

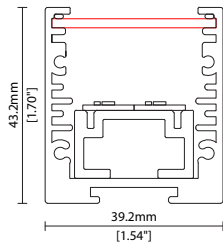

**B** Clear Cover

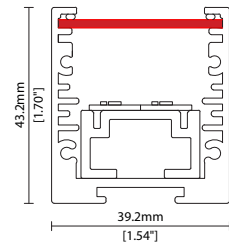

**C** Diffused Cover

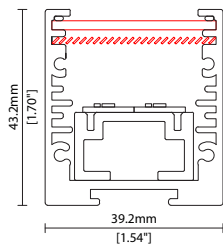

**K** Clear Cover + Micro Louvre

## CABLE EXIT OPTIONS

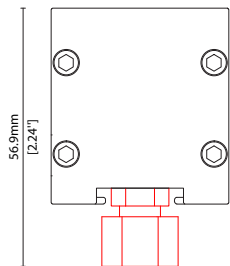

**RC** Rear cable exit

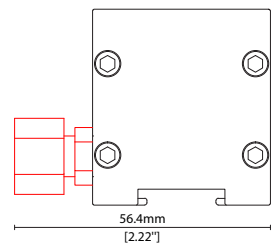

**SC** Side cable exit

### POWER FEED OPTIONS

\* Options are an integral part of the fixture ordering codes. Please refer to **Code Table** pages.

**1000 S00B 1000mm (39.37") Single ø6.3mm sheath tail**

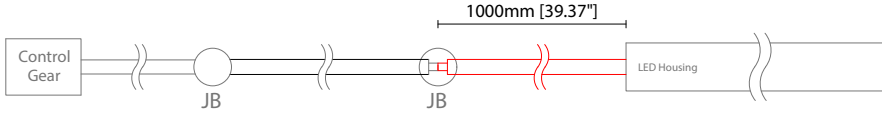

**1000 D00B 1000mm (39.37") Double ø6.3mm sheath tail**

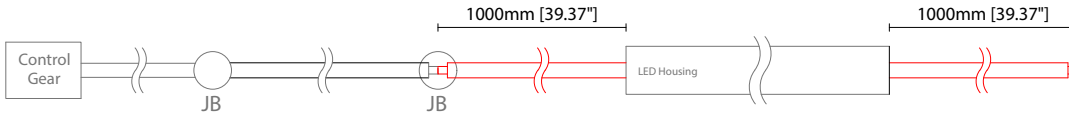

**0300 S67B 300mm (11.81") Single ø6.3mm sheath IP67 connector**

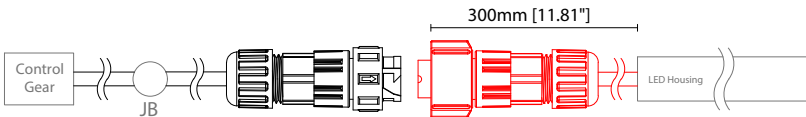

**0300 D67B 300mm (11.81") Double ø6.3mm sheath IP67 connector**

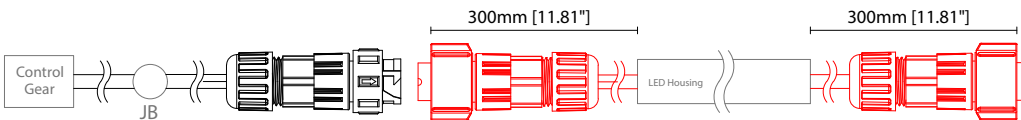

### IP67 2 Pin Connector

Female connector  
2 PIN (IP67)

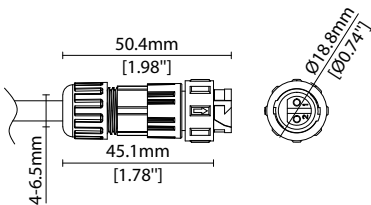

Male connector  
2 PIN (IP67)

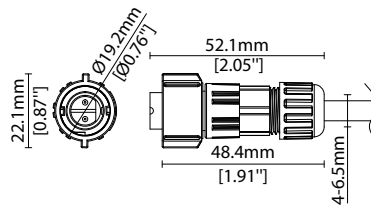

### Key

- Control Gear Power supply, sub-controllers & control systems
- JB Junction box / cable connection

## MOUNTING ACCESSORIES

Note: Accessories are to be ordered separately with corresponding code shown below.



**KKCP-12**

Lock clip (allow 2 per metre/40in)  
S/Steel finish

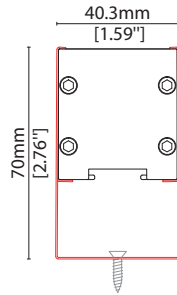

**KKBK-02**

Fixed bracket (allow 2 per metre/40in)  
Steel finish  
Pre-assembled for double tail

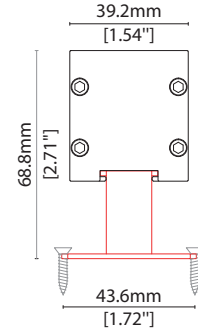

**KKBK-09**

Mounting plate  
(allow 2 per metre/40in – factory fitted)  
Silver anodised aluminium finish  
Pre-assembled for double tail

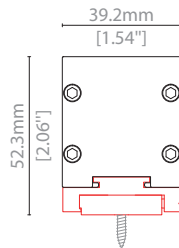

**KKBK-23**

Low adjustable bracket  
(allow 2 per metre/40in)  
Silver anodised aluminium finish  
Pre-assembled for double tail

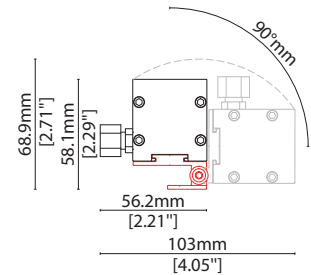

**KKBK-16**

Small adjustable bracket  
(allow 2 per metre/40in)  
Silver anodised aluminium finish  
Pre-assembled for double tail

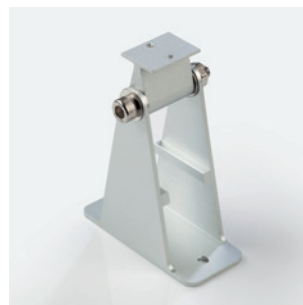
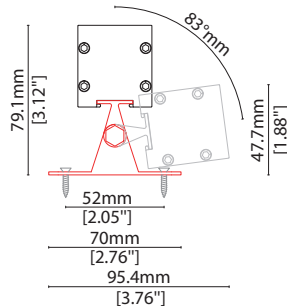

**KKBK-17**

Large adjustable bracket  
(allow 2 per metre/40in)  
Silver anodised aluminium finish  
Pre-assembled for double tail

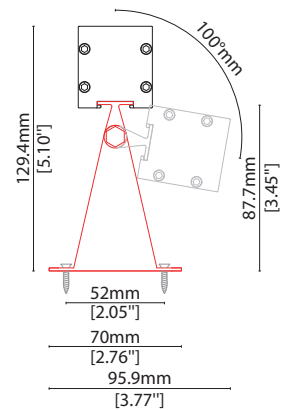



Linear

# SEN CV A030x2 (60W) Accessories

# KKDC

## EXTERIOR JUNCTION BOXES

---



KKJB-07

IP67 Slim J-Box  
(including type A,B,C,D bushings)



KKJB-07R

Potting resin for IP67 Slim J-Box

### AVAILABLE PSU OPTIONS

Control Mode	PSU (Order Code)	Input Voltage AC	Output Voltage DC	Rated Output Current	Rated Power	Dim %	IP Rating
Switched	CEN-60-24	90-295V	24V	2.5A	60W	-	IP67
	HLG-60H-24	90-305V	24V	2.5A	60W	-	IP67
	HLG-100H-24	90-305V	24V	4.0A	100W	-	IP67
	HLG-150H-24	90-305V	24V	6.3A	150W	-	IP67
	HLG-240H-24	90-305V	24V	10A	240W	-	IP67
0-10V (1-10V)	PWM-40-24	90-305V	24V	1.67A	40W	100-0.15 (100-10)	IP67
	PWM-60-24	90-305V	24V	2.5A	60W	100-0.15 (100-10)	IP67
	PWM-90-24	90-305V	24V	3.67A	90W	100-0.15 (100-10)	IP67
	PWM-120-24	90-305V	24V	5.0A	120W	100-0.15 (100-10)	IP67
DALI	LIN100A1	120-277V	24V	1A per channel	100W	100-0.1	IP66/IP40
DMX RGB	LIN100A1	120-277V	24V	1.33A per channel	100W	100-0.1	IP66/IP40
DMX RGBW	LIN100A1	120-277A	24V	1A per channel	100W	100-0.1	IP66/IP40

### Flicker Free Options - Combination of PSU+ sub-controller

Control Mode	PSU (Order Code)	Sub-controller (Order Code)	Input Voltage AC	Output Voltage DC	Rated Output Current	Rated Power	Dim %	IP Rating PSU/ Sub-controller
0-10V or 1-10V	CEN-60-24	KKDM-06	90-295V	24V	2.5A	60W	100-0.9	IP67/IP20
	HLG-60H-24	KKDM-06	90-295V	24V	2.5A	60W	100-0.9	IP67/IP20
	HLG-100H-24	KKDM-06	90-295V	24V	4.0A	100W	100-0.9	IP67/IP20
	HLG-150H-24	KKDM-06	90-295V	24V	6.3A	150W	100-0.9	IP67/IP20
	HLG-240H-24	KKDM-06	90-295V	24V	10.0A	240W	100-0.9	IP67/IP20
DALI	CEN-60-24	KKDL-02/03	90-295V	24V	2.5A	60W	100-0.1	IP67/IP20
	HLG-60H-24	KKDL-02/03	90-305V	24V	2.5A	60W	100-0.1	IP67/IP20
	HLG-100H-24	KKDL-02/03	90-305V	24V	4.0A	100W	100-0.1	IP67/IP20
	HLG-150H-24	KKDL-02/03	90-305V	24V	6.3A	150W	100-0.1	IP67/IP20
	HLG-240H-24	KKDL-02/03	90-305V	24V	10.0A	240W	100-0.1	IP67/IP20
DMX RGB	CEN-60-24	KKSC-05	90-295V	24V	2.5A	60W	100-0.9	IP67/IP20
	HLG-60H-24	KKSC-05	90-305V	24V	2.5A	60W	100-0.9	IP67/IP20
	HLG-100H-24	KKSC-05	90-305V	24V	4A	100W	100-0.9	IP67/IP20
	HLG-150H-24	KKSC-05	90-305V	24V	6.3A	150W	100-0.9	IP67/IP20
	HLG-240H-24	KKSC-05	90-305V	24V	10.0A	240W	100-0.9	IP67/IP20

<sup>1</sup> The items shown above cover the most frequently used specification but does not exhaust the possible options

<sup>2</sup> PSU and/or driver can be chosen from the table, or KKDC may recommend the best option upon receipt of the controls requirement and installation environment

<sup>3</sup> Electrical shop drawing will include detailed information of PSU and relevant control drivers

<sup>4</sup> Cut sheets are available on the controls section of [www.kkdc.lighting](http://www.kkdc.lighting) or upon request